



TEST REPORT

For FCC Part15B

Report No.: **CHEW22090080**

Project No.: **SHT2103098304EW**

Applicant's name: **HARDWARIO a.s.**

Address.....: U Jezu 525/4, 460 01 Liberec, CZECHIA

Product Name: **CHESTER**

Trade Mark: -

Model No.: CHESTER

Listed Model(s): -

Standard: **47 CFR FCC Part 15 Subpart B**

Date of receipt of test sample.....: Jun. 29, 2022

Date of testing.....: Jun. 30, 2022- Sep. 20, 2022

Date of issue.....: Sep. 21, 2022

Result.....: **Pass**



Compiled by
 (position+printed name+signature)...: File administrators Silvia Li

Supervised by
 (position+printed name+signature)...: Project Engineer David Chen

Approved by
 (position+printed name+signature)...: RF Manager Hans Hu

Silvia Li

David Chen

Hans Hu

Testing Laboratory Name: **Shenzhen Huatongwei International Inspection Co., Ltd.**

Address.....: 1/F, Bldg 3, Hongfa Hi-tech Industrial Park, Genyu Road, Tianliao, Gongming, Shenzhen, China

Shenzhen Huatongwei International Inspection Co., Ltd. All rights reserved.

This publication may be reproduced in whole or in part for non-commercial purposes as long as the Shenzhen Huatongwei International Inspection Co., Ltd. is acknowledged as copyright owner and source of the material. Shenzhen Huatongwei International Inspection Co., Ltd. takes no responsibility for and will not assume liability for damages resulting from the reader's interpretation of the reproduced material due to its placement and context.

The test report merely corresponds to the test sample.

Contents

1.	<u>TEST STANDARDS AND REPORT VERSION</u>	<u>3</u>
1.1.	Test Standards	3
1.2.	Report version information	3
2.	<u>TEST DESCRIPTION</u>	<u>4</u>
3.	<u>SUMMARY.....</u>	<u>5</u>
3.1.	Client Information	5
3.2.	Product Description	5
3.3.	Testing Laboratory Information	5
4.	<u>TEST CONFIGURATION.....</u>	<u>6</u>
4.1.	Descriptions of test mode	6
4.2.	Environmental conditions	6
4.3.	Statement of the measurement uncertainty	6
4.4.	Equipments Used during the Test	7
5.	<u>TEST CONDITIONS AND RESULTS</u>	<u>8</u>
5.1.	Radiated Emissions Test	8
6.	<u>TEST SETUP PHOTOS OF THE EUT</u>	<u>12</u>
7.	<u>EXTERNAL AND INTERNAL PHOTOS OF THE EUT</u>	<u>13</u>

1. TEST STANDARDS AND REPORT VERSION

1.1. Test Standards

The tests were performed according to following standards:

[47 CFR FCC Part 15 Subpart B](#) - Unintentional Radiators

[ANSI C63.4: 2014](#) – American National Standard for Methods of Measurement of Radio-Noise Emissions from Low-Voltage Electrical and Electronic Equipment in the Range of 9 kHz to 40GHz

1.2. Report version information

Revision No.	Date of issue	Description
N/A	2022-09-21	Original

2. TEST DESCRIPTION

Section	Test Item	Section in CFR 47	Result #1	Test Engineer
	Conducted Emissions	15.107(a)	N/A	N/A
5.1	Radiated Emissions	15.109(a)	PASS	Pan Xie

Note:

#1: The test result does not include measurement uncertainty value

3. SUMMARY

3.1. Client Information

Applicant:	HARDWARIO a.s.
Address:	U Jezu 525/4, 460 01 Liberec, CZECHIA
Manufacturer:	HARDWARIO a.s.
Address:	U Jezu 525/4, 460 01 Liberec, CZECHIA

3.2. Product Description

Main unit information:	
Product Name:	CHESTER
Trade Mark:	-
Model No.:	CHESTER
Listed Model(s):	-
Power supply:	DC 3.6V from Primary lithium battery
Hardware version:	R3.2
Software version:	v1.0.0

3.3. Testing Laboratory Information

Laboratory Name	Shenzhen Huatongwei International Inspection Co., Ltd.	
Laboratory Location	1/F, Bldg 3, Hongfa Hi-tech Industrial Park, Genyu Road, Tianliao, Gongming, Shenzhen, China	
Connect information:	Tel: 86-755-26715499 E-mail: cs@szhtw.com.cn http://www.szhtw.com.cn	
Qualifications	Type	Accreditation Number
	FCC	762235

4. TEST CONFIGURATION

4.1. Descriptions of test mode

Test mode	Description
Working mode	Keep the EUT in power on and active status

Pre-scan above all test mode, found below test mode which it was worse case mode, so only show the test data for worse case mode on the test report

Test Item	Test mode for worse case
Radiated Emissions	YPHT21030983005

4.2. Environmental conditions

During the measurement the environmental conditions were within the listed ranges:

Temperature:	15~35°C
Relative Humidity:	30~60 %
Air Pressure:	950~1050mba

4.3. Statement of the measurement uncertainty

Test Items	MeasurementUncertainty
Radiated emission	<1GHz: 4.22dB >1GHz:5.06ppm

This uncertainty represents an expanded uncertainty expressed at approximately the 95% confidence level using a coverage factor of k=1.96.

4.4. Equipments Used during the Test

● Radiated emission-6th test site							
Used	Test Equipment	Manufacturer	Equipment No.	Model No.	Serial No.	Last Cal. Date (YY-MM-DD)	Next Cal. Date (YY-MM-DD)
●	Semi-Anechoic Chamber	Albatross projects	HTWE0127	SAC-3m-02	C11121	2018/09/30	2023/09/29
●	EMI Test Receiver	R&S	HTWE0099	ESCI	100900	2022/08/30	2023/08/29
●	Loop Antenna	R&S	HTWE0170	HFH2-Z2	100020	2021/04/06	2024/04/05
●	Ultra-Broadband Antenna	SCHWARZBECK	HTWE0123	VULB9163	538	2021/04/06	2024/04/05
●	Pre-Amplifier	SCHWARZBECK	HTWE0295	BBV 9742	N/A	2021/11/05	2022/11/04
●	RF Connection Cable	HUBER+SUHNER	HTWE0062-01	N/A	N/A	2022/02/25	2023/02/24
●	RF Connection Cable	HUBER+SUHNER	HTWE0062-02	SUCOFLEX104	501184/4	2022/02/25	2023/02/24
●	Test Software	R&S	N/A	ES-K1	N/A	N/A	N/A

● Radiated emission-7th test site							
Used	Test Equipment	Manufacturer	Equipment No.	Model No.	Serial No.	Last Cal. Date (YY-MM-DD)	Next Cal. Date (YY-MM-DD)
●	Semi-Anechoic Chamber	Albatross projects	HTWE0122	SAC-3m-01	C11121	2018/09/27	2023/09/26
●	Spectrum Analyzer	R&S	HTWE0098	FSP40	100597	2022/08/25	2023/08/24
●	Horn Antenna	SCHWARZBECK	HTWE0126	9120D	1011	2020/04/01	2023/03/31
●	Broadband Horn Antenna	SCHWARZBECK	HTWE0103	BBHA9170	BBHA9170472	2020/04/27	2023/04/26
●	Pre-amplifier	CD	HTWE0071	PAP-0102	12004	2021/11/05	2022/11/04
●	Broadband Pre-amplifier	SCHWARZBECK	HTWE0201	BBV 9718	9718-248	2022/02/28	2023/02/27
●	RF Connection Cable	HUBER+SUHNER	HTWE0120-01	6m 18GHz S Serisa	N/A	2022/02/25	2023/02/24
●	RF Connection Cable	HUBER+SUHNER	HTWE0120-02	6m 3GHz RG Serisa	N/A	2022/02/25	2023/02/24
●	RF Connection Cable	HUBER+SUHNER	HTWE0119-05	6m 3GHz RG Serisa	N/A	2022/02/25	2023/02/24
●	RF Connection Cable	HUBER+SUHNER	HTWE0120-04	6m 3GHz RG Serisa	N/A	2022/02/25	2023/02/24
●	Test Software	Audix	N/A	E3	N/A	N/A	N/A

5. TEST CONDITIONS AND RESULTS

5.1. Radiated Emissions Test

LIMIT

FCC CFR Title 47 Part 15 Subpart B Section 15.109

Frequency	Limit (dBuV/m @3m)	Value
30MHz-88MHz	40.00	Quasi-peak
88MHz-216MHz	43.50	Quasi-peak
216MHz-960MHz	46.00	Quasi-peak
960MHz-1GHz	54.00	Quasi-peak
Above 1GHz	54.00	Average
	74.00	Peak

TEST CONFIGURATION

➤ 30MHz ~ 1GHz

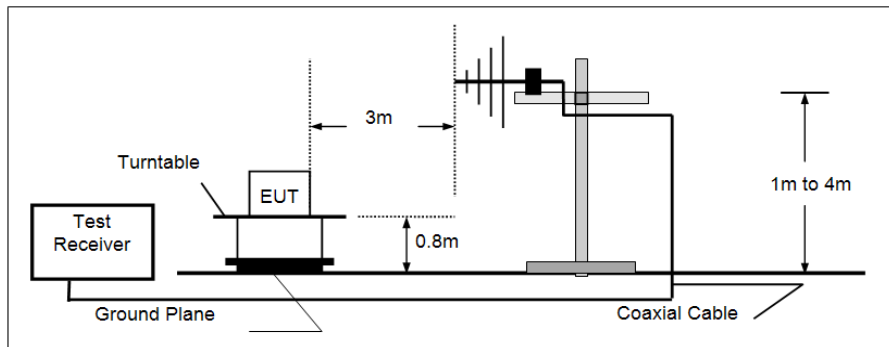

➤ Above 1GHz

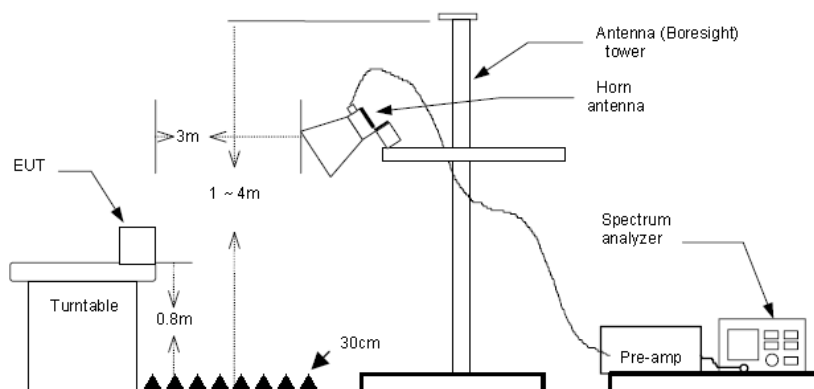

TEST PROCEDURE

- The EUT was tested according to ANSI C63.4:2014.
- The EUT is placed on a turn table which is 0.8 meter above ground.
- The turn table is rotated 360 degrees to determine the position of the maximum emission level.
- The EUT was positioned such that the distance from antenna to the EUT was 3 meters.
- The antenna is scanned from 1 meter to 4 meters to find out the maximum emission level. This is repeated for both horizontal and vertical polarization of the antenna.
- Use the following spectrum analyzer settings
 - Span shall wide enough to fully capture the emission being measured;
 - Below 1GHz,
RBW=120KHz, VBW=300KHz, Sweep=auto, Detector function=peak, Trace=max hold;
If the emission level of the EUT measured by the peak detector is 3 dB lower than the applicable limit, the peak emission level will be reported. Otherwise, the emission measurement will be repeated using

the quasi-peak detector and reported.
(3) From 1GHz to 5th harmonic, RBW=1MHz, VBW=3MHz

TEST MODE:

Please refer to the clause 3.3

TEST RESULTS

Passed **Not Applicable**

Note: Final Level =Receiver Read level + Antenna Factor + Cable Loss – Preamplifier Factor
The emission levels of frequency above 6GHz are very lower than limit and not show in test report.

Polarization:

Horizontal

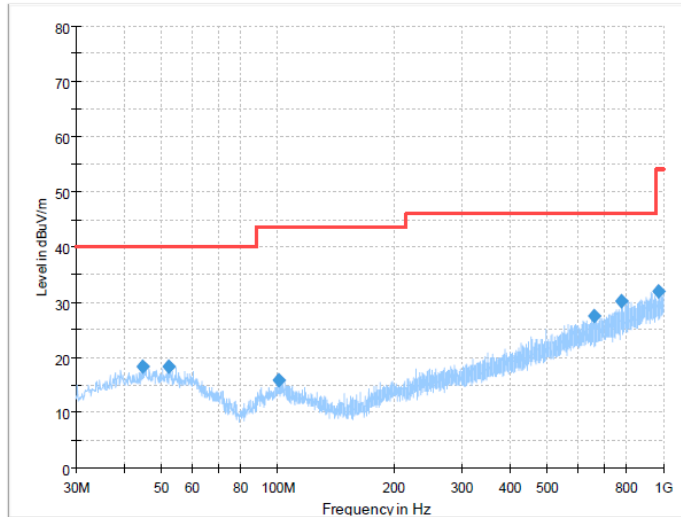

Serif,

Final Result

Frequency (MHz)	MaxPeak (dBuV/m)	Limit (dBuV/m)	Margin (dB)	Height (cm)	Pol	Azimuth (deg)	Corr. (dB/m)
44.550000	18.31	40.00	21.69	100.0	H	111.0	-9.4
52.067500	18.42	40.00	21.58	100.0	H	151.0	-9.3
100.931250	15.96	43.50	27.54	100.0	H	188.0	-10.8
662.197500	27.57	46.00	18.43	100.0	H	170.0	1.6
778.718750	30.16	46.00	15.84	100.0	H	291.0	3.9
969.323750	32.05	54.00	21.95	100.0	H	303.0	7.5

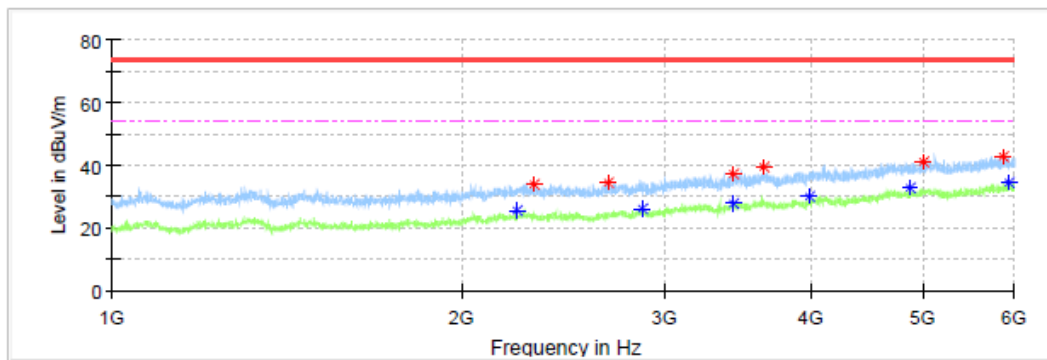

Critical Freqs

Frequency (MHz)	MaxPeak (dBuV/m)	Average (dBuV/m)	Limit (dBuV/m)	Margin (dB)	Height (cm)	Pol	Azimuth (deg)	Corr. (dB/m)
2309.375000	33.99	---	74.00	40.01	150.0	H	88.0	-4.6
3650.000000	39.60	---	74.00	34.40	150.0	H	107.0	-0.5
4875.000000	---	33.03	54.00	20.97	150.0	H	149.0	5.7
5011.875000	41.17	---	74.00	32.83	150.0	H	149.0	6.5
2671.875000	34.42	---	74.00	39.58	150.0	H	191.0	-3.8
2236.250000	---	25.49	54.00	28.51	150.0	H	219.0	-4.5
3996.250000	---	30.15	54.00	23.85	150.0	H	233.0	1.2
5940.000000	---	34.50	54.00	19.50	150.0	H	247.0	9.2
3430.000000	---	28.05	54.00	25.95	150.0	H	289.0	-1.4
2862.500000	---	25.85	54.00	28.15	150.0	H	331.0	-3.3
3436.250000	37.01	---	74.00	36.99	150.0	H	331.0	-1.3
5875.625000	42.92	---	74.00	31.08	150.0	H	345.0	8.7

Polarization:

Vertical

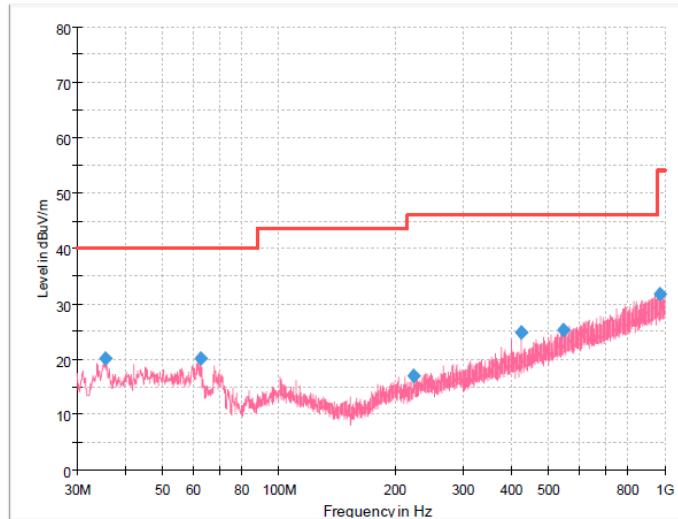

Serif,

Final Result

Frequency (MHz)	MaxPeak (dBuV/m)	Limit (dBuV/m)	Margin (dB)	Height (cm)	Pol	Azimuth (deg)	Corr. (dB/m)
35.456250	20.13	40.00	19.87	100.0	V	339.0	-11.0
62.616250	20.18	40.00	19.82	100.0	V	238.0	-10.8
224.121250	16.89	46.00	29.11	100.0	V	297.0	-10.0
423.698750	24.88	46.00	21.12	100.0	V	309.0	-3.8
547.858750	25.28	46.00	20.72	100.0	V	290.0	-0.5
968.111250	31.66	54.00	22.34	100.0	V	320.0	7.5

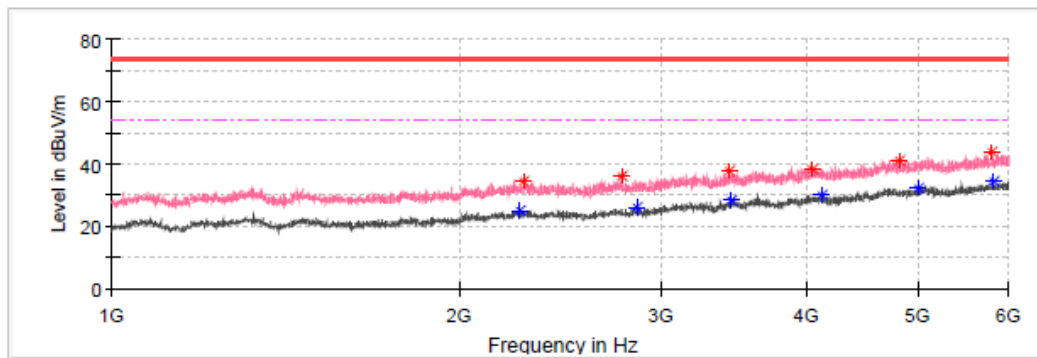

Critical Freqs

Frequency (MHz)	MaxPeak (dBuV/m)	Average (dBuV/m)	Limit (dBuV/m)	Margin (dB)	Height (cm)	Pol	Azimuth (deg)	Corr. (dB/m)
2280.000000	34.45	---	74.00	39.55	150.0	V	0.0	-4.6
2763.750000	36.16	---	74.00	37.84	150.0	V	0.0	-3.5
3441.250000	---	28.32	54.00	25.68	150.0	V	0.0	-1.3
4131.250000	---	30.20	54.00	23.80	150.0	V	0.0	1.8
4823.125000	41.25	---	74.00	32.75	150.0	V	111.0	5.5
5810.625000	43.68	---	74.00	30.32	150.0	V	139.0	8.4
2260.000000	---	25.13	54.00	28.87	150.0	V	153.0	-4.6
5004.375000	---	32.37	54.00	21.63	150.0	V	153.0	6.5
3432.500000	37.56	---	74.00	36.44	150.0	V	251.0	-1.4
5811.875000	---	34.28	54.00	19.72	150.0	V	282.0	8.4
2850.000000	---	26.04	54.00	27.96	150.0	V	326.0	-3.4
4048.125000	38.45	---	74.00	35.55	150.0	V	341.0	1.5

6. TEST SETUP PHOTOS OF THE EUT

Radiated Emissions (30MHz-1GHz)



Radiated Emissions (Above 1GHz)



7. EXTERNAL AND INTERNAL PHOTOS OF THE EUT

EXTERNAL PHOTOS OF THE EUT

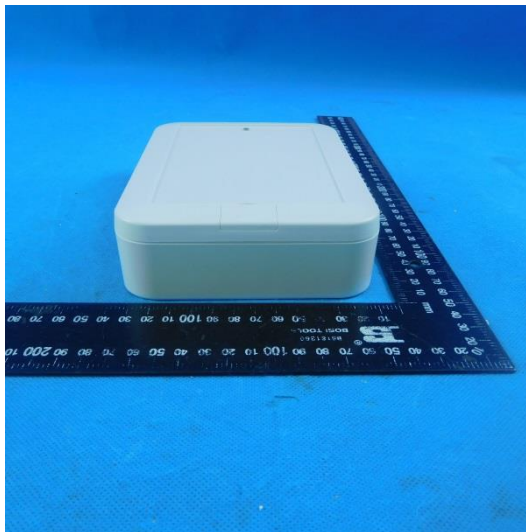
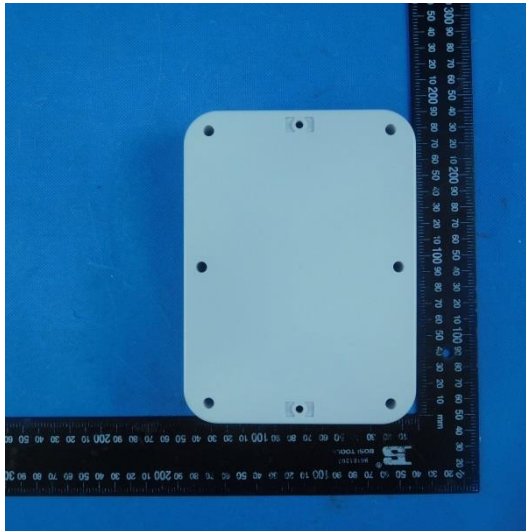
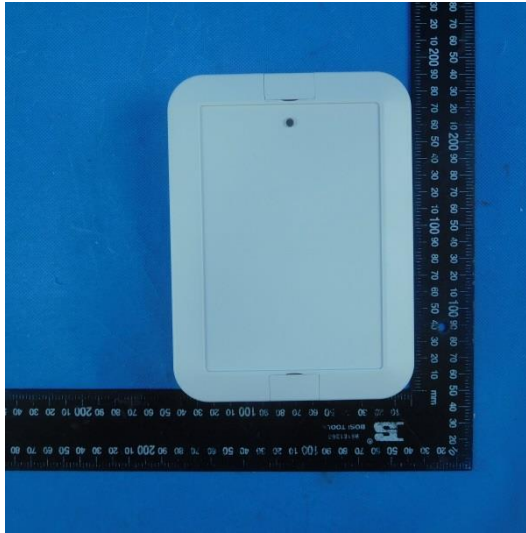

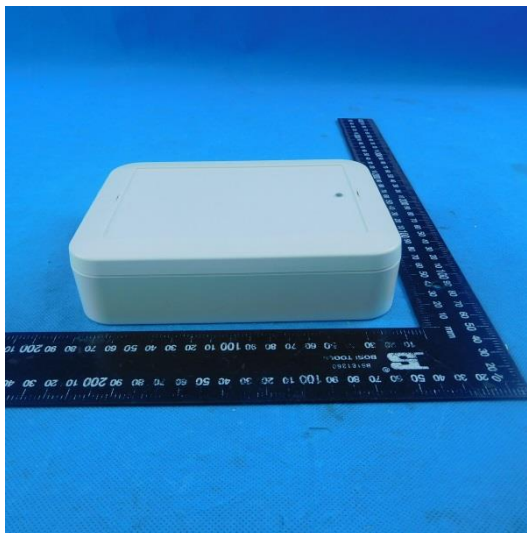

INTERNAL PHOTOS OF THE EUT

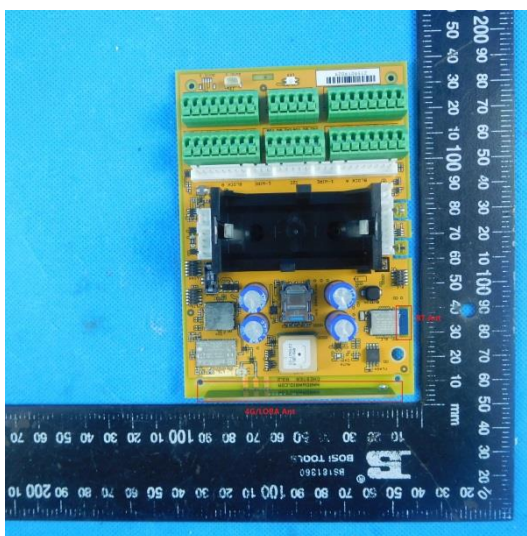
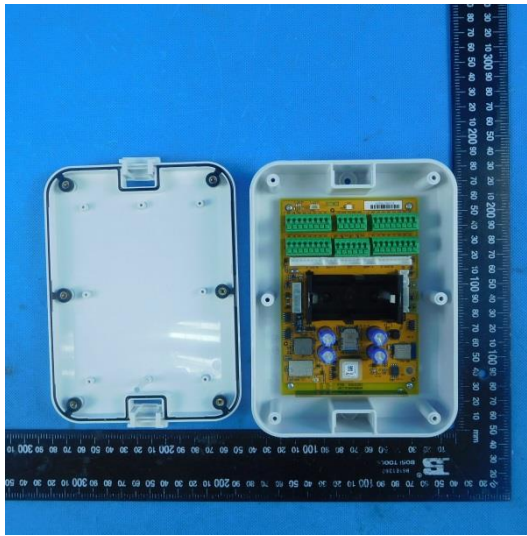

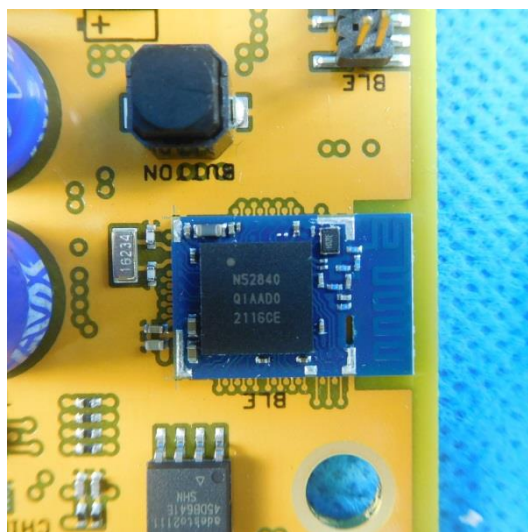
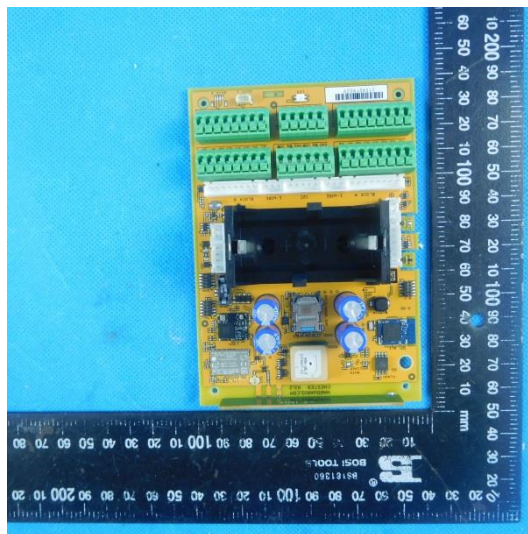
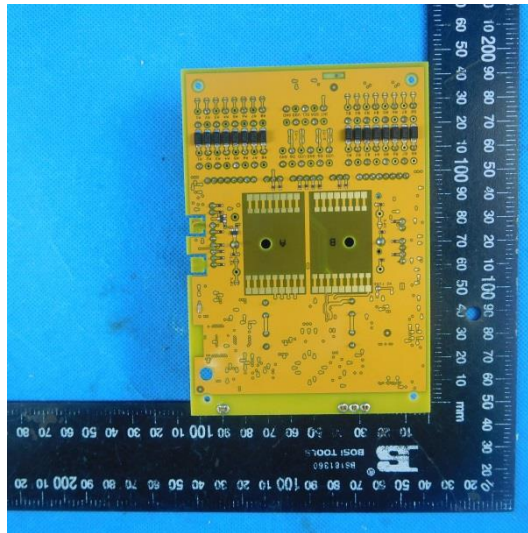

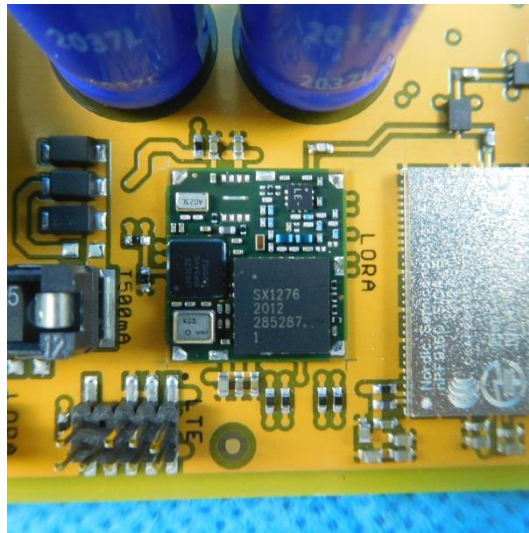

-----End of Report-----